



LED WALL WASHER

ITEM NO.: G2GLWW-5 Series

INSTRUCTION OF LED WALL WASHER

This product is mainly used for decorating and highlighting in building frame, garden, etc. It can work in independent mode and DMX mode, which can generate various color changing effects, such as flashing, fading, steady, seven color jumping synchronously etc. DMX256 class gray degree dimmer, DMX programable(thousands of effects. available if many lights being connected together);

A. Specification:

A-1. Structure:

Material of Shell: Aluminum alloy/6063
 Rotary angle: 140°
 Input Voltage: 90~305V AC
 Operating Voltage: 24V DC
 Protection Rating: IP65
 Operating Temperature: -20°C-40°C



LWW-5-36P

A-2. Model Configuration Table

Model No.	Color	LED Quantity	Power Consumption	Beam Angle	Size	Weight
G2GLWW-5-18P	R/G/B/CW/NW/WW/RGB	18	20 WATTS	10°/30°/45°	L580xW(147/78)xH(70/118)mm	2.80kg±5%
G2GLWW-5-36P	R/G/B/CW/NW/WW/RGB	36	40 WATTS	10°/30°/45°	L1240xW(147/78)xH(70/118)mm	5.5kg±5%

B. Working Mode:

B-1. Independent Mode: Choose the build-in programs via the buttons on the end cover.

B-2. DMX Mode: International standard DMX512 signal(IP68 connector).

B-3. Master/Slave Mode: Auto online and synchro working.

B-1. Mode indépendant: Choisissez les programmes de construction en passant par les boutons sur la couverture de fin

B-2. Mode DMX: signal de norme internationale DMX512(connecteur Ip68).

B-3. Mode maître / esclave: Auto en ligne et travail synchro.

C. Function & Setup

C-1. DMX Addressing

When the digital LED is not flashing, press A, digital LED begin to flash, press A once, active digital LEDs moves backward, you can start to edit the second digital LED; Press B, the corresponding flash digital LED increase one bit(the values between 1 to 9);

*** Valid DMX Address:001~510

Lorsque le voyant numérique ne clignote pas, appuyez sur A, numérique LED commence à clignoter, appuyez une fois, actifs LED numériques se déplace vers l'arrière, vous pouvez commencer à éditer le second LED numérique; Appuyez sur B, le numérique flash LED correspondant augmenter un bit (les valeurs entre 1 à 9).





LED WALL WASHER

ITEM NO.: G2GLWW-5 Series

C-2. Independent Mode

After pressing A four times (the first three times is the setup on DMX address) or B directly, light enter into independent mode; the digital LEDs show PXY, press A once, active digital LEDs move backward, you can choose function via X and parameter via Y;

Press B, the corresponding flash digital LED increase one bit (range: 1~9)

Après avoir appuyé sur A quatre reprises (les trois premières fois est la configuration de l'adresse DMX) ou B directement, lumière entrer dans le mode indépendant; les voyants numériques montrent PXY, appuyez une fois, les LED numériques actifs se déplacent vers l'arrière, vous pouvez choisir la fonction via le X et le paramètre par Y; augmentations Appuyez sur B, le numérique de flash LED correspondante un peu (de 1 à 9).

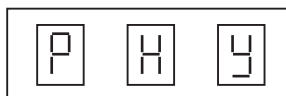

X refer to functions (the value between 1 to C), Y refer to value of speed and gray degree for the functions (the value between 1 to 9).

X référence à des fonctions (la valeur entre 1 et C), Y se référer à la valeur de la vitesse et le degré de gris pour les fonctions (valeur entre 1 et 9).

Function and parameter sheet:

X value	Y value
1-static red	1-9 class gray degree
2-static green	1-9 class gray degree
3-static yellow	1-9 class gray degree
4-static blue	1-9 class gray degree
5-static purple	1-9 class gray degree
6-static cyan	1-9 class gray degree

X value	Y value
7-static white	1-9 class gray degree
8-multicolor changing	1-9 class speed
9-single fading	1-9 class speed
A-multicolor fading	1-9 class speed
B-multicolor flashing	1-9 class speed
C-aurun	1-9 times circle

C-3. Master/Slave Mode

Choose any one light as the master for attaining auto online function, the operations are as below: firstly, set the address of master as 001, others are set as slave (address can be any one except 001); Change function of the master (001) light, then all lights will work synchronously

Choisissez une quelconque lumière en tant que maître pour atteindre la fonction automatique de ligne, les opérations sont les suivantes: premièrement, définir la adresse du maître comme 001, d'autres sont définies comme esclave (adresse peut être l'un quelconque sauf 001); la fonction de changement de la maître (001) de lumière, puis toutes les lumières ne fonctionnent de manière synchrone;

C-4. When pressing button, please wait for about 10 sec, then you can exit the mode of adjustment function, the digital LED stop flashing and data recorded.

Lorsque appuyant sur le bouton, s'il vous plaît patienter pendant environ 10 secondes, puis vous pouvez quitter le mode de la fonction de réglage, le numérique LED cesse de clignoter et les données enregistrées.

D. Photometric Parameters

D-1. Cadela Distribution

LWW-5-36P

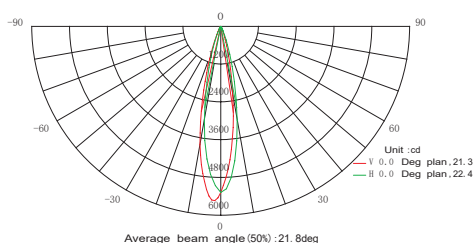

RGB

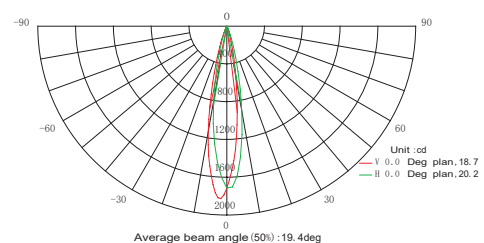

Red



LED WALL WASHER

ITEM NO.: G2GLWW-5 Series

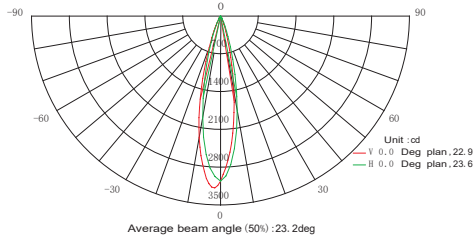

Green

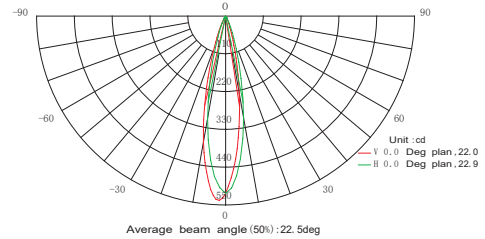

Blue

D-2. Illuminance At A Distance

LWW-5-36P

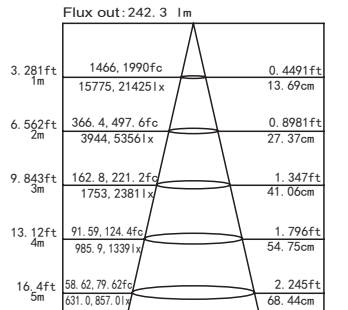

Note: The curve is illuminance area under different projection distance and the average illuminance in the area.

RGB

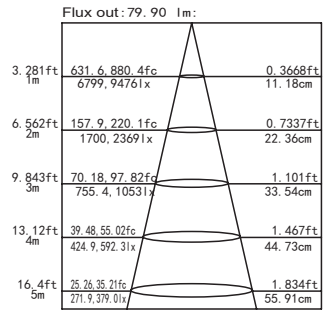

Note: The curve is illuminance area under different projection distance and the average illuminance in the area.

Red

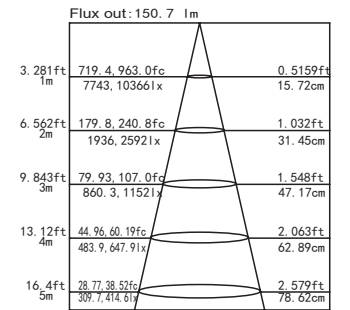

Note: The curve is illuminance area under different projection distance and the average illuminance in the area.

Green

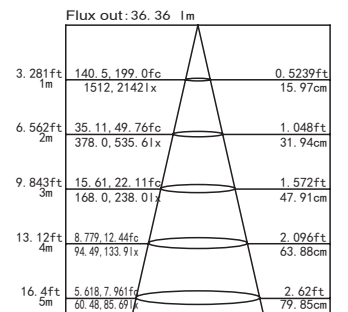

Note: The curve is illuminance area under different projection distance and the average illuminance in the area.

Blue

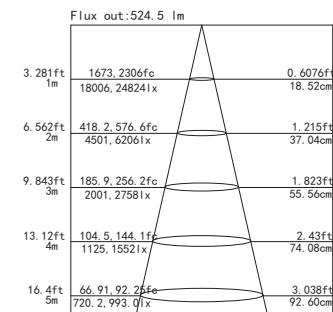

Note: The curve is illuminance area under different projection distance and the average illuminance in the area.

White

E. Dimension Drawing

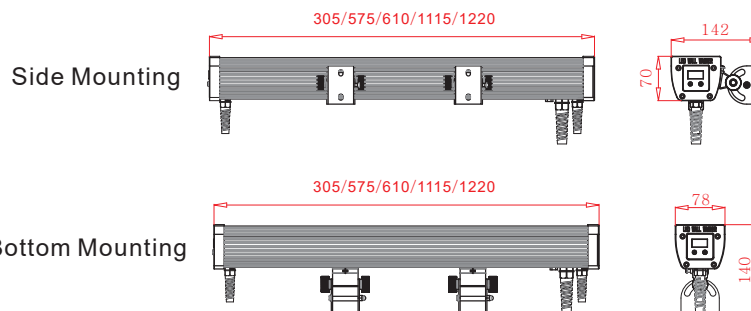



LED WALL WASHER

ITEM NO.: G2GLWW-5 Series

F. Installation Drawing:

Fix the brackets via M4 tapping screw, mounting size as below:

Fixer les supports via M4 Vis Parker, la taille de montage ci-dessous:

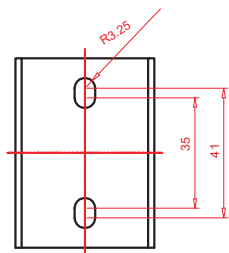

Bottom & Side Mounting

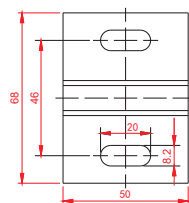

Bottom Mounting

Caution:

1. Do not plug them into power when the product is still in package;
2. Don't use anything to cover the fixture during application;
3. Don't use this product in close environment;
4. If this product appears to be damaged, do not attempt any repair, please contact your dealer.

Warning:

- * Neglect on action of the above treatment will lead to failure of waterproof and proper working of the lights!!!
- * Make sure the ground connection well avoid electric shock, due to metal housing.

Caution:

1. Ne pas les brancher au pouvoir lorsque le produit est toujours en emballage;
2. Ne pas utiliser quoi que ce soit pour couvrir l'appareil lors de l'application;
3. Ne pas utiliser ce produit en étroite environnement;
4. Si ce produit semble endommagé, n'essayez pas toute réparation, s'il vous plaît contactez votre revendeur.

Warning:

- * Négligence sur l'action du traitement ci-dessus conduira à l'échec de imperméable et bon travail des lumières!
- * Assurez-vous que la connexion à la terre et éviter choc électrique, grâce à un boîtier métallique.

Note: The above instruction are subject to update or improved without notice. Pls turn to our staff for further details !

Thanks for your long term support !



Do not install the lamp in the lightning activity area.
N'installez pas la lampe dans la zone d'activité de l'éclairage.